

QUICK START GUIDE

MC6N-ECAT

P960 - P965

SAFETY WARNING

During the installation or use of control systems, users of Trio products must ensure that there is no possibility of injury to any person or damage to machinery.

Control systems, especially during installation, can malfunction or behave unexpectedly. Bearing this in mind, users must ensure that even in the event of a malfunction or unexpected behaviour, the safety of an operator or programmer is never compromised.

MINIMUM CONNECTIONS

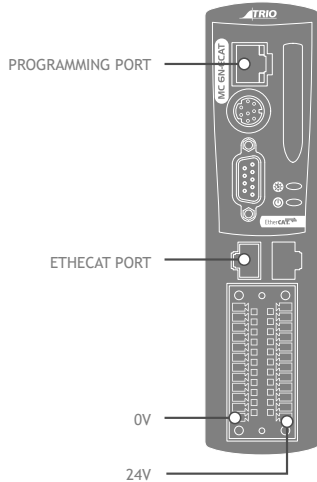

OPTIONAL CONNECTIONS

Serial ports

Auxiliary Flexible Axis Port

I/O Connections

Enable (Watchdog)

CONNECTORS

I/O / Power (24V) connector:

Note: Use ferrules on all wires for best connection.

1. Connection: Push wire into hole of connector. Tighten screw. Insert connector into MC6N.
2. Removal: Reverse the procedure.

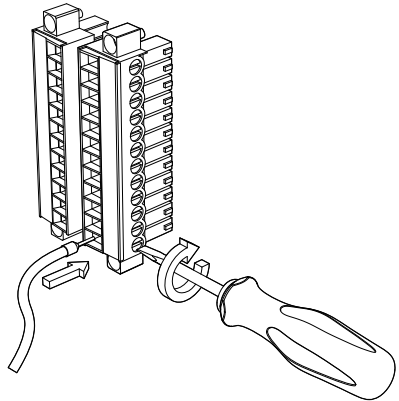

RJ45 ETHERNET CONNECTOR (TOP)

A standard Ethernet connector is provided for use as the primary programming interface.

The Trio programming software, *Motion Perfect 4.3* and above, must be installed on a Windows based PC that is fitted with an Ethernet connection. The IP address is displayed on the MC6N display for a few seconds after power-up or when an Ethernet cable is plugged in.

The Standard Ethernet connection may also be used for Ethernet-IP, Modbus and other factory communications.



ETHERCAT PORT

The MC4N acts as an EtherCAT master. EtherCAT drives and I/O devices are normally connected in a chain.

Ethernet standard pin assignment:

Pin	Signal	Description
1	TD+	Transmission data +
2	TD-	Transmission data -
3	RD+	Receive data +
6	RD-	Receive data -

Symetric or cross-over cables can be used between EtherCAT devices. Minimum CAT 5 shielded SF/UTP cable is recommended.

ETHERCAT NETWORK DETECTION

The screenshot shows the 'Intelligent drives' window with a sub-window for 'Slot 0 - EtherCAT'. The 'Diagram' section shows a network topology with 'Master State: Operational'. The diagram includes a table for addresses and axes:

Address	1	2	4	3
Axis	0	1	3	2

Below the diagram is a table of detected drives:

Axis	Ctrl Mode	Model	Pos	Alias	Configured
0	EthCAT Pos	MADHT1505B01	0	0	1
1	EthCAT Pos	AKD	1	0	2
3	EthCAT Pos	SanyoDenki RS2 EtherCAT	2	0	4
2	EthCAT Pos	Digitax ST	3	3	3

A 'Modify STARTUP Program' button is located at the bottom left of the window.

EtherCAT Inteigent drives Window in Motion Perfect

SERIAL CONNECTIONS (8 WAY MINI-DIN)

Pin	Function	Note
1	RS485 Data In A Rx+	Serial Port #2
2	RS485 Data In B Rx-	
3	RS232 Transmit	Serial Port #1
4	0V Serial	
5	RS232 Receive	Serial Port #1
6	5V Output	150mA max*
7	RS485 Data Out Z Tx-	Serial Port #2
8	RS485 Data Out Y Tx+	

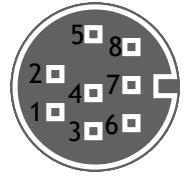

* Current shared with encoder port

FLEXIBLE AXIS PORT (9 WAY D-TYPE)

Pin	Encoder	Stepper Axis	Absolute Encoder
1	Enc. A	Step +	Clock
2	Enc. /A	Step -	/Clock
3	Enc. B	Direction +
4	Enc. /B	Direction -
5	0V Serial/Encoder	0V Serial/Encoder	0V Serial/Encoder
6	Enc. Z	Enable +	Data
7	Enc. /Z	Enable -	/Data
8	5V*	5V*	5V*
9	Not Connected	Not Connected	Not Connected

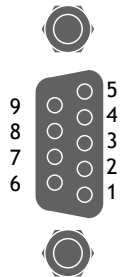

*Current limit is 150mA max shared with serial port.

SHIELDING THE FLEXIBLE AXIS PORT

Ensure that:

1. The shield screw is grounded as close to the MC6N as possible.
2. 0V connection is NOT used for terminating screens.
3. Pin 5 of Encoder/Stepper plug is connected to 0V on drive.
4. Encoder cable screen is clamped to 9 way D shell.
5. The MC6N 24V supply has common 0V with the drive(s).



WHEN WIRING MC6N STEPPER OUTPUT TO A DIFFERENTIAL INPUT STEPPER DRIVE, USE THE 0V AND SHIELD CONNECTIONS SHOWN FOR THE ENCODER. THE STEPPER DRIVE MUST HAVE ITS COMMON 0V CONNECTED TO THE MC6N.

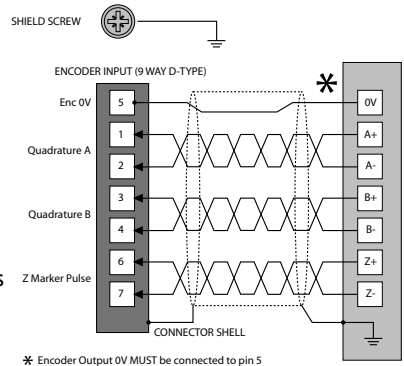

I/O CONNECTOR

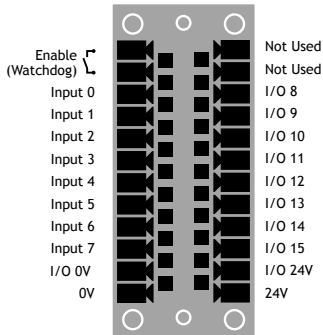

I/O CIRCUITS

Inputs 0 - 3 have fast opto-couplers for use as axis registration inputs. Inputs 4 - 7 may also be used as registration inputs.

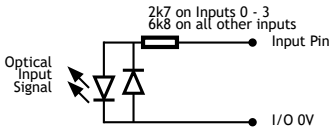

Inputs / Outputs 8 - 15

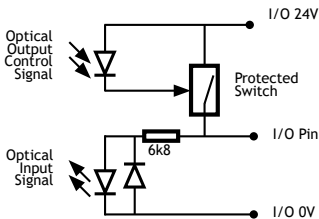

AMPLIFIER ENABLE (WATCHDOG) RELAY OUTPUT

An internal relay may be used to enable external amplifiers when the controller has powered up correctly and the system and application software are ready. The amplifier enable is a single pole solid state relay with a normally open “contact”. The enable relay contact will be open circuit if there is no power on the controller OR an axis error exists OR the user program sets it open with the WDOG=OFF command.



ETHERCAT DRIVES WILL BE ENABLED VIA THE ETHERCAT NETWORK SO THE “AMPLIFIER ENABLE” CONNECTION IS NOT NORMALLY REQUIRED.

ALL NON ETHERCAT STEPPER AND SERVO AMPLIFIERS MUST BE INHIBITED WHEN THE AMPLIFIER ENABLE OUTPUT IS OPEN CIRCUIT.

An additional safety relay may be required so as to meet machine safety approvals.

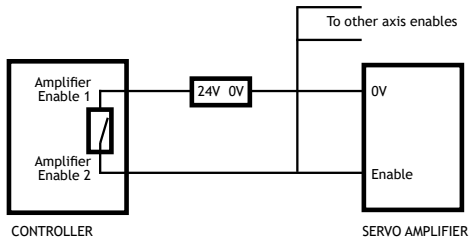

Enable

Input 0

Input 1

Input 2

Input 3

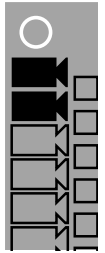

DISPLAY

The IP address and subnet mask of the MC6N is shown on the LCD display for a few seconds after power-up. The factory default IP address is 192.168.0.250. This can be changed using the IP_ADDRESS command via the *Motion Perfect* software tool or SD Card.

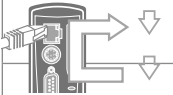
	Display Example	Description	Details
	↓ SYS	Displayed on controller start	
	↓ 960	Model code : Displayed on power up	P960 : 2 axes P961 : 4 axes P962 : 8 axes P963 : 16 axes P964 : 32 axes P965 : 64 axes
	↓ 192.168.0.250	IP Address :	Displayed on power up OR after ethernet connection for 15 seconds
	↓ RUN / OFF	Enable status	
	↓ Err XXX	Error codes	Ann : Error on Axis nn Unn : Unit error on slot nn Caa : Configuration error on unit nn, ie: too many axes E04 : VR/TABLE corrupt entry

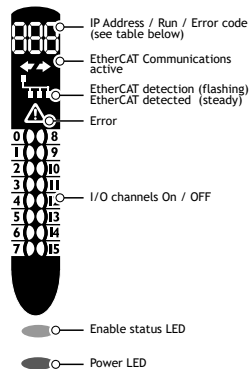

5-WAY CANBUS CONNECTOR

This is a 5 way 3.5mm pitch connector. The connector is used both to provide the 24 Volt power to the MC6N CAN circuit and provide connections for I/O expansion via Trio's CAN I/O expanders. A 24V dc, Class 2 transformer or power source should be used.

This 24V input is internally isolated from the I/O 24V and main 24V power.



THE CAN CONNECTOR MAY BE LEFT UNUSED. THE MC6N IS GROUNDED VIA THE METAL CHASSIS. FIT A SHORT SHIELD CONNECTION BETWEEN THE CHASSIS EARTH SCREW AND THE EARTHED METAL MOUNTING PANEL / PLATE.

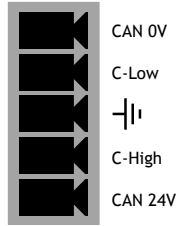

SD CARD

The SDHC Card (high density) may be used for storing or transferring programs, recipes and data to and from the MC6N. The card must be FAT32 format and a maximum 32Gb size.



SD CARDS MAY BE FAT16 FORMATTED WHEN PURCHASED. RE-FORMAT IN A PC TO FAT32 PRIOR TO USE.

NETWORK SETUP

Network connection

Set IP_ADDRESS in MC6N to an available unused address. It **MUST** match the subnet in use. Set the PC to use DHCP server.

Note: the MC6N always has a fixed IP address.

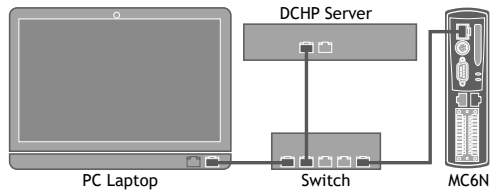

Point-to-point or closed network

(No DHCP server)

The PC MUST be set to a fixed IP_ADDRESS.

The first 3 "octets" **MUST** be the same as the MC6N and the last **MUST** be different, but not 000, 254 or 255.

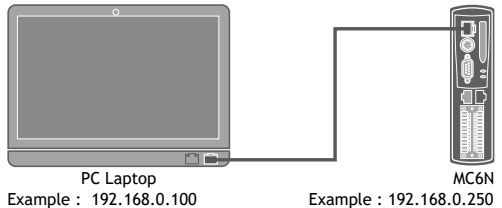

Setting a fixed IP address

In Windows 7. Open "Network and Sharing Centre" then change "Adapter Settings". Select the properties of the Local Area Network and the IPv4 properties. The IP Address is set to 192.168.0.100 with subnet mask set to 255.255.255.0. Assuming that the MC6N has IP_ADDRESS=192.168.0.250 or similar.

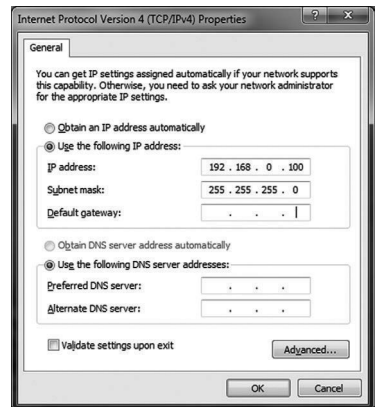

CHASSIS MOUNTING DIMENSIONS (LOOKING FROM FRONT)

M4 screws should be used in 2 places to mount the MC6N to an unpainted metal panel.

The best EMC performance is obtained when the MC6N is attached from the shield screw (marked) using a flat braided conductor with a cross section of 4mm x 1mm. Do NOT use a circular section wire or run the braid to a central star point.



ENSURE THAT THE VENTILATION SLOTS AT THE TOP AND BOTTOM OF THE MC6N ARE KEPT CLEAR TO ENSURE A FREE FLOW OF AIR THROUGH THE MODULE.

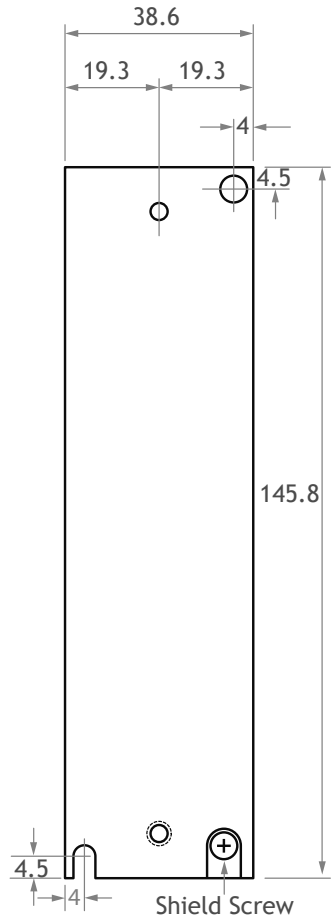

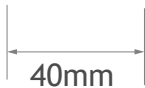
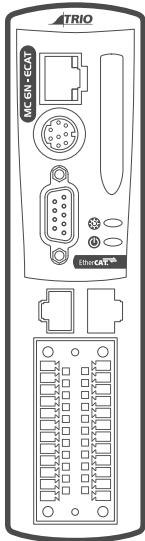

40mm

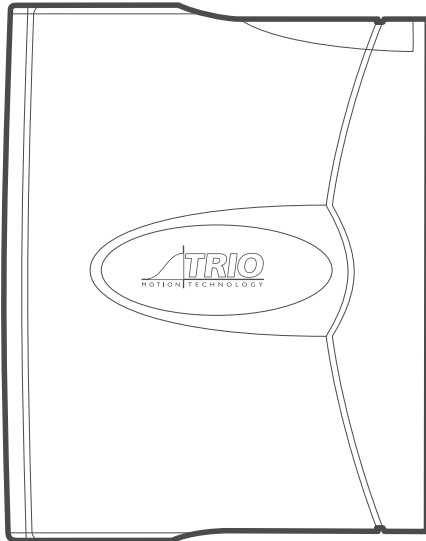

120mm



157mm

UK | USA | CHINA | INDIA
WWW.TRIMOTION.COM
THE MOTION SPECIALIST

CAD data Drawings to aid packaging and mounting are available in various formats from the Trio web site. Products should be wired by qualified persons.
Specifications may change without notice. E & OE

Quick Start v1 March 2018